

Project Preparation

Table of Contents

| | |
|---|-----------|
| MODEL | 1 |
| NEW PROJECT | 2 |
| DEFINING THE TYPE OF THE STRUCTURE AND BACKGROUND MEDIUM | 2 |
| DRAWING THE STRUCTURE | 4 |
| DRAWING THE PORTS | 12 |
| SETTING BOUNDARY CONDITIONS | 16 |
| SETTING UP THE MESH | 18 |
| EXPORTING THE PROJECT AND RUNNING THE SIMULATION | 20 |

Model

The model is a parallel plate transmission line excited with a plane wave (red transmission line port) and terminated with a load port (green transmission line port) matched to the line. The transmission line is filled with air and a concrete material slab is placed in the middle.

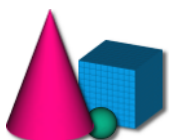
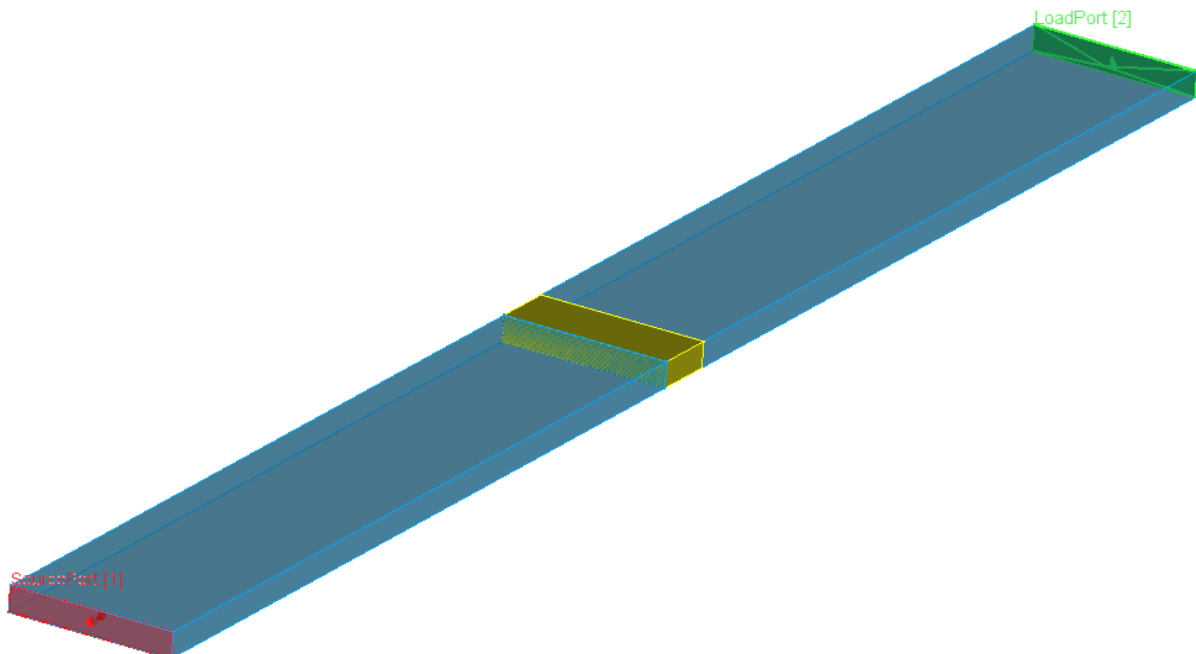

New Project

Having the *QW-Modeller* opened press  button from the Ribbon to create new project. Press



button and save it with the *ppw7.QWpro* name.

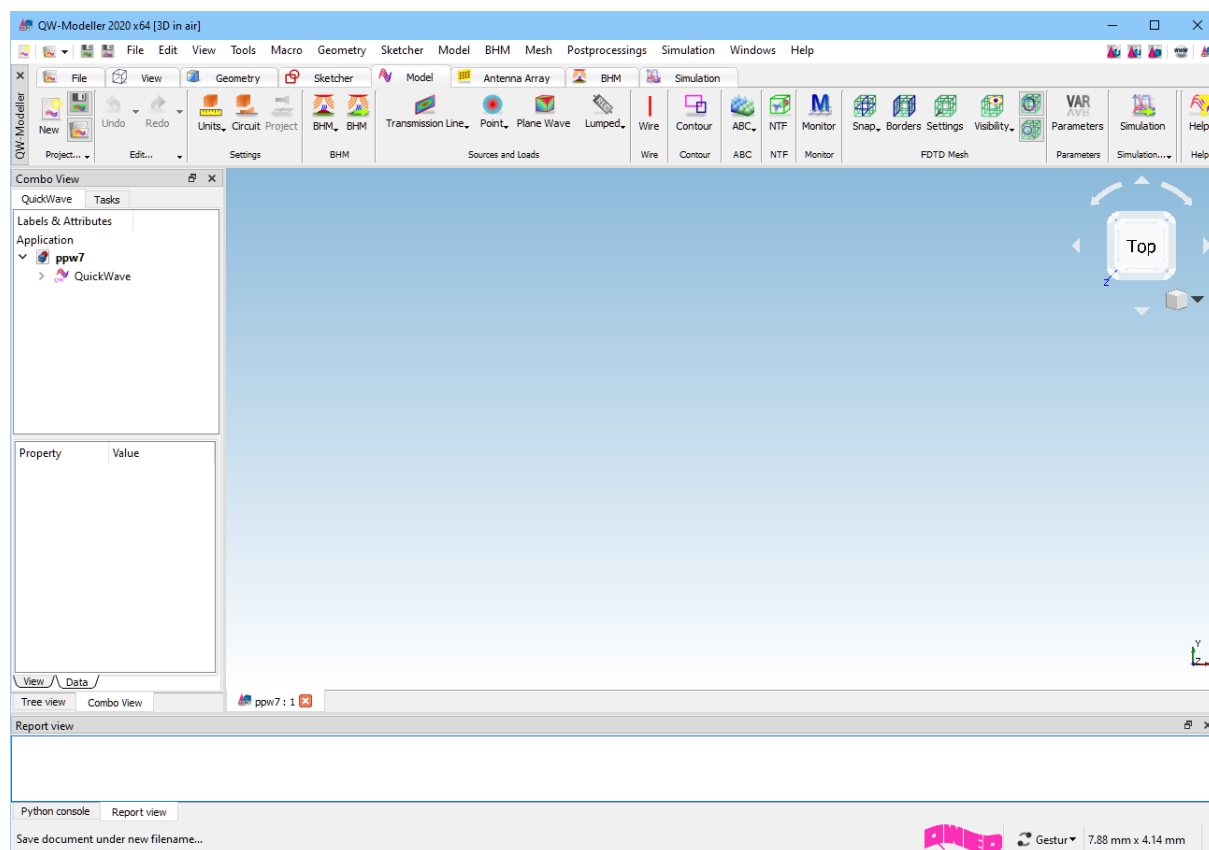

Defining the type of the structure and background medium

Having the *QW-Modeller* opened and a new project document created, we can proceed with defining the type of the structure. First of all, we need to specify if we will be dealing with typical three dimensional (3D) or maybe periodic three dimensional (3DP) structures. The structure type, called also the *circuit type*, is determined in the *Circuit Settings* dialogue available in the *Model* tab, under



the *Circuit* **Circuit** push button. In case of our parallel plate line we will be analysing typical 3D circuit.

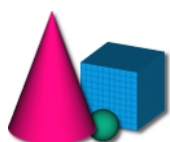

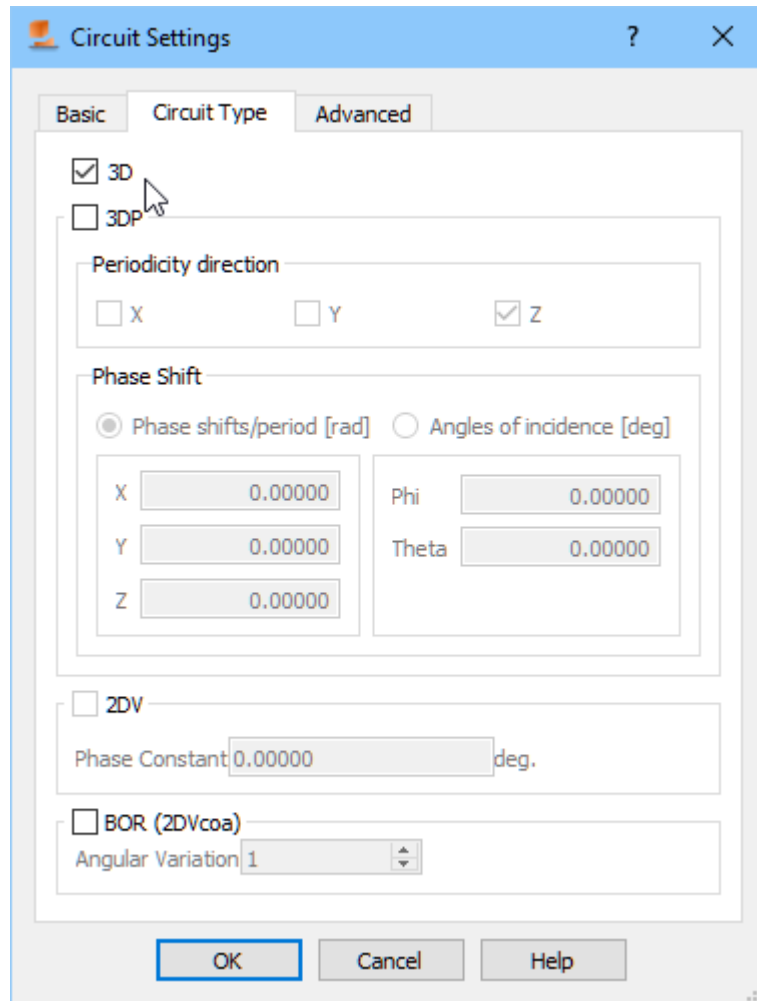

At this stage it is necessary to determine also the background medium for the structure. Since the structure is non-radiating and we are interested only in the fields inside it (it is a closed structure type of problem), we can set the background medium to metal and then draw only the inside of the structure. To set the background medium, we switch to *Basic* tab in the *Circuit Settings* dialogue and choose metal from the *Background Medium* combo box. Please note that there is a choice of only two possible background media, *air* and *metal*.

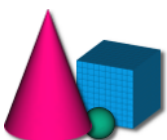

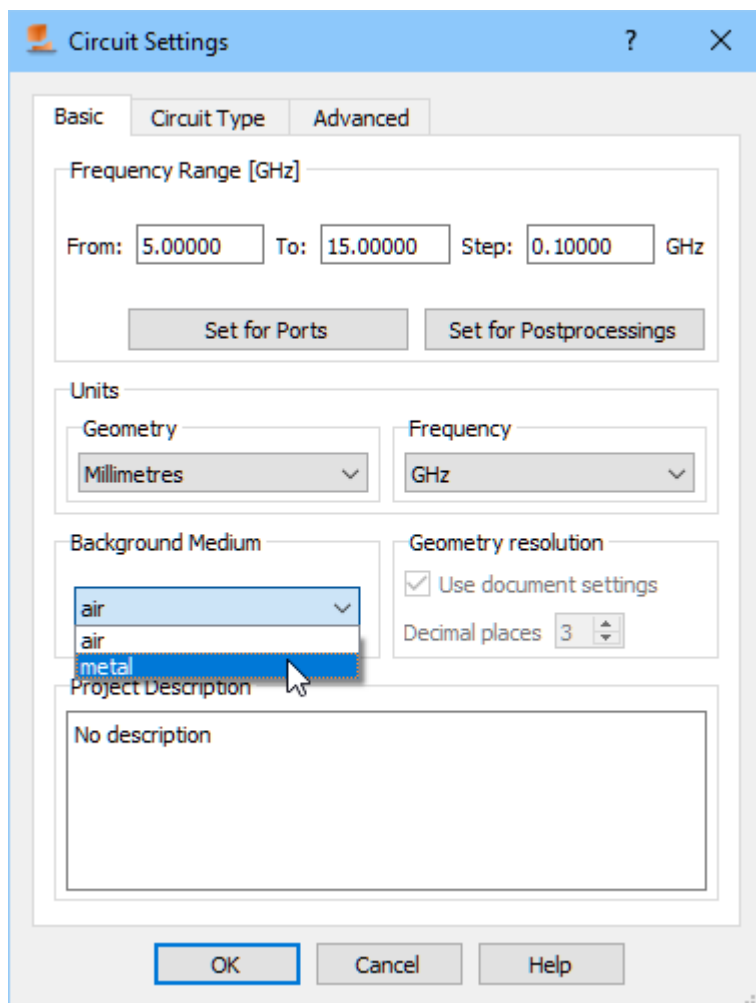

Drawing the structure

At this stage we will be creating the project geometry. First step that needs to be accomplished is choosing the units that will describe the geometry. To do that we go to *Model* tab and from *Units*



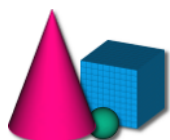

Units button we choose *Millimetres*. The same can be done in the *Basic* tab in the *Circuit Settings* dialogue.

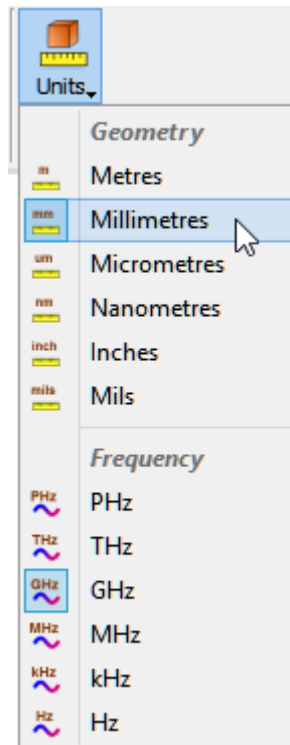

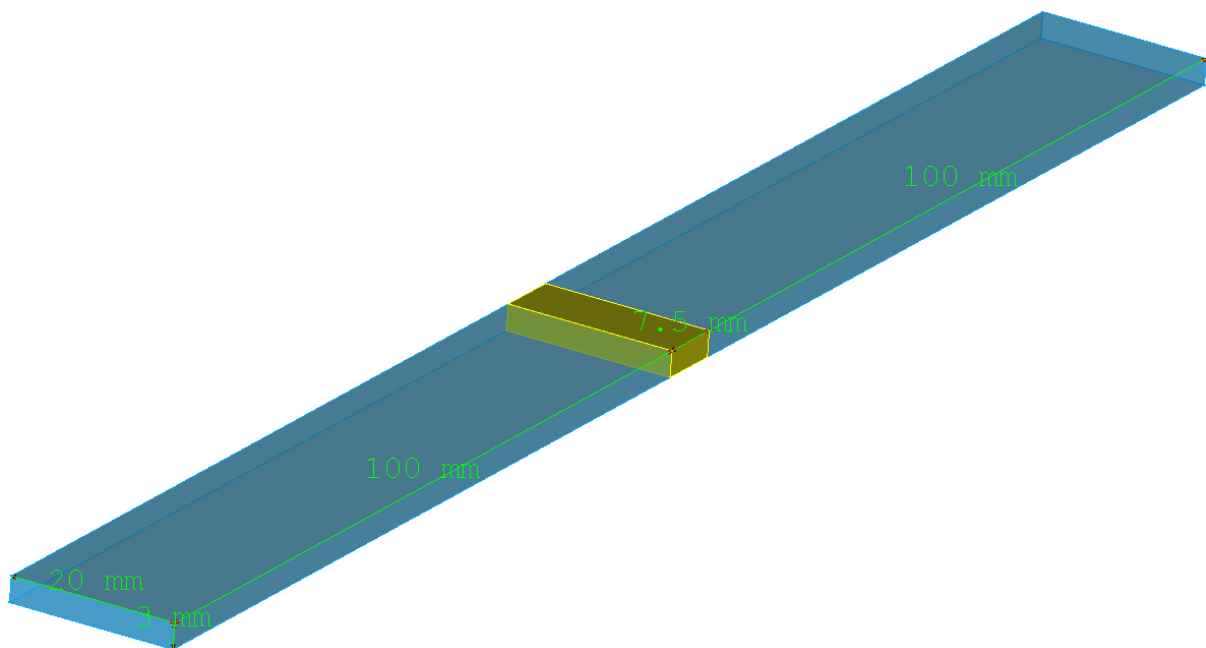

The dimensions of the transmission line are as follow:



To draw the structure we go to *Geometry* tab. We start from drawing the transmission line inside. Firstly, the first part filled with air is drawn. We need to draw only the inside of the structure (the surrounding medium is metal), thus we start from the air block, which stands for the first part of the transmission line inside. To draw the transmission line we press *Create a Box*  button in the *Primitives* section and a dialogue appears.

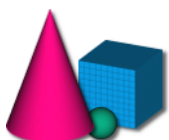

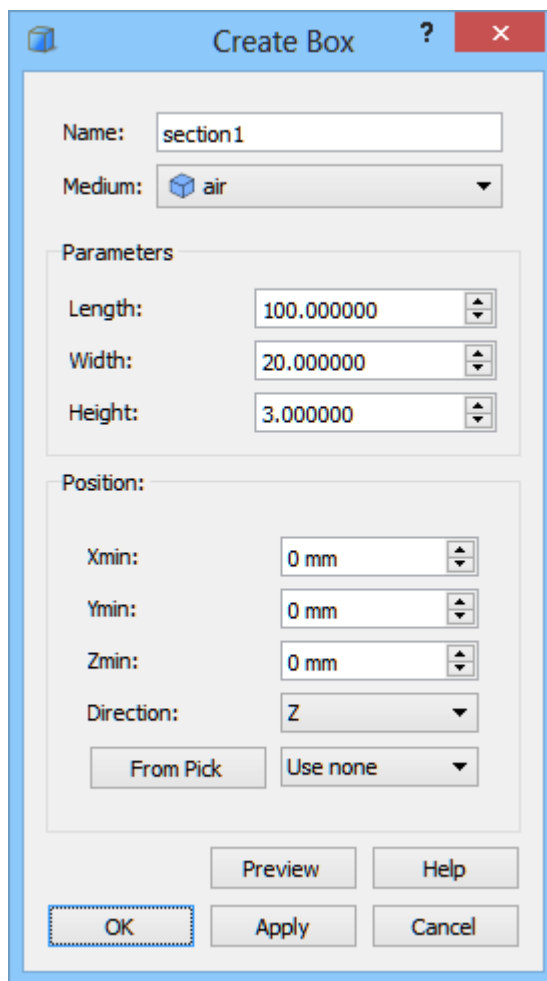

From the *Medium* combo box we choose air. Now we can proceed to setting the dimensions of the air filled part according to the picture above. With *Position* set to (0,0,0) the transmission line will be drawn so that its lower right corner is placed at this coordinates. After pressing *OK* button the air filled part appears in the project.

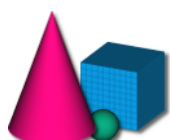

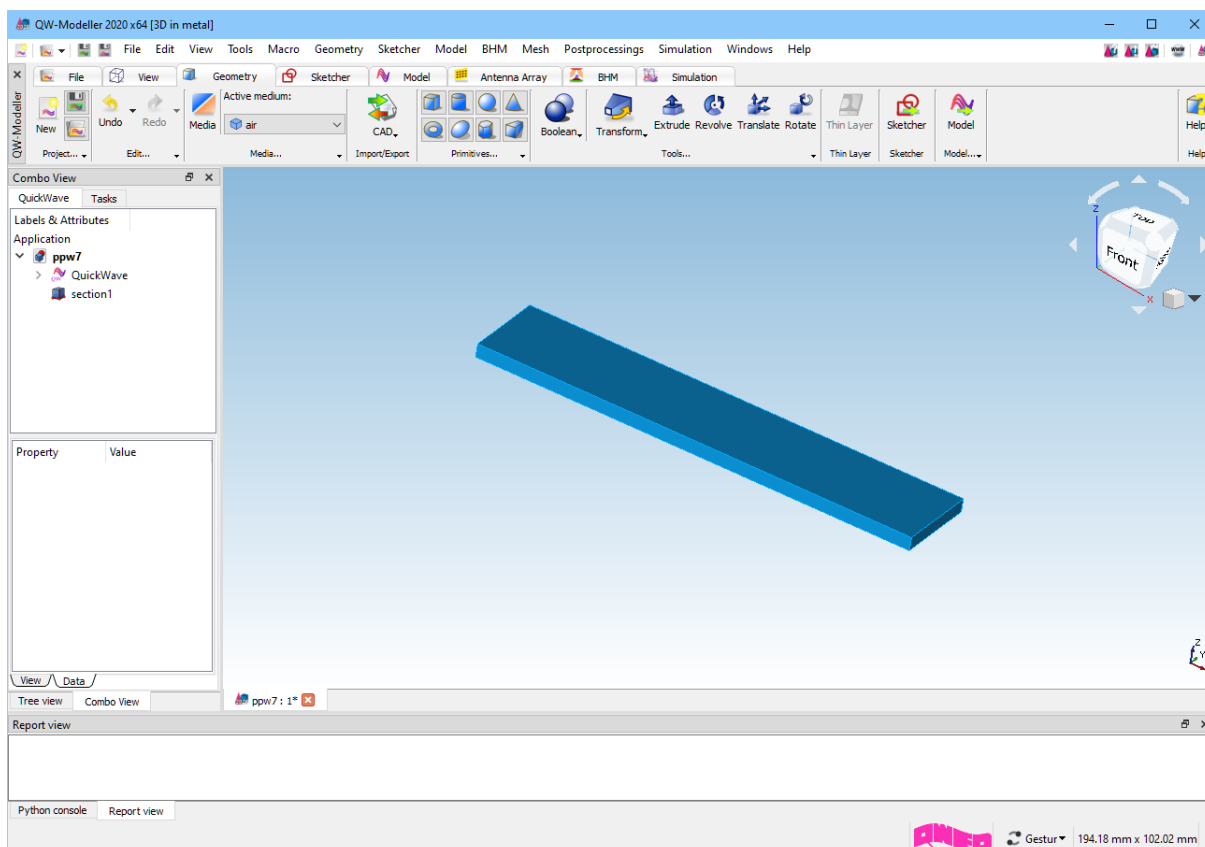

Before drawing the concrete slab it is required to define concrete medium in the project. For that

purpose we press **Media** button in the *Geometry* tab and in the appearing *Project Media* dialogue we press *Add* button.

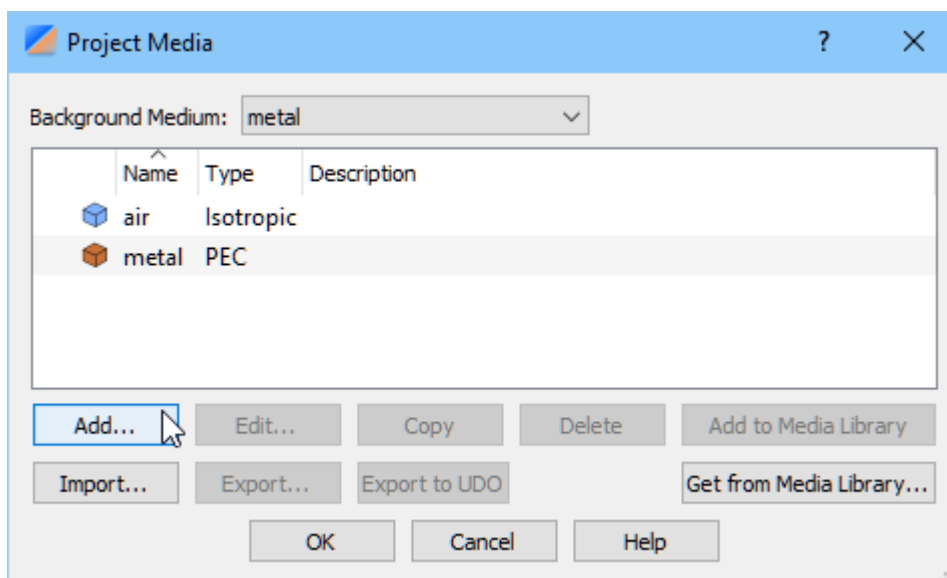

In the *Edit Medium* dialogue we set the medium name to “concrete” and its relative permittivity to 4. Pressing *OK* button introduces the concrete medium to the project.

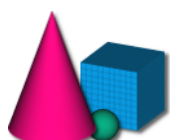

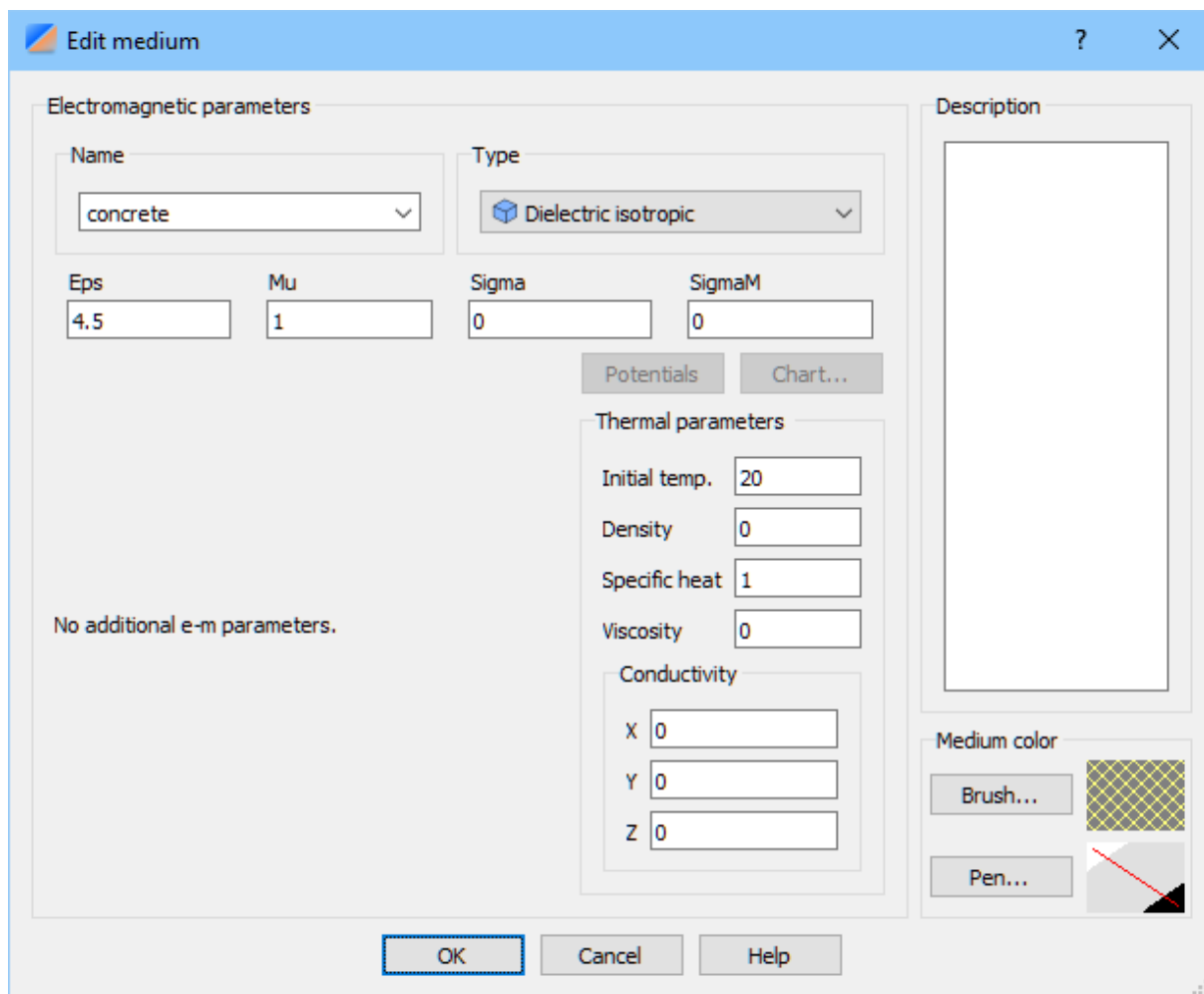

We now proceed to drawing the concrete filled part of the transmission line. We press *Create a Box*  button in the *Primitives* section and a dialogue appears.

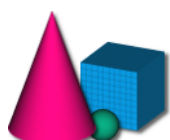

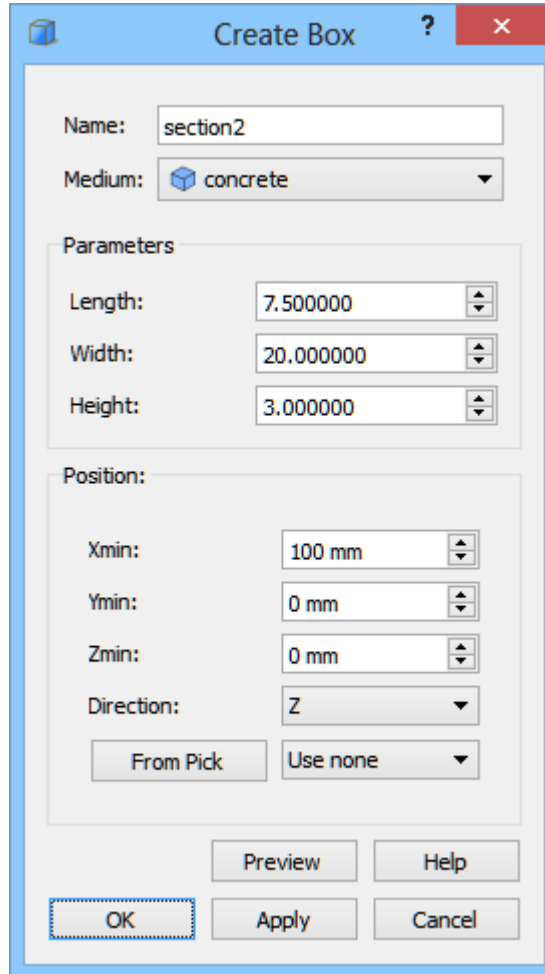



The screenshot shows a 'Create Box' dialog box with the following settings:

- Name: section2
- Medium: concrete
- Parameters:
 - Length: 7.500000
 - Width: 20.000000
 - Height: 3.000000
- Position:
 - Xmin: 100 mm
 - Ymin: 0 mm
 - Zmin: 0 mm
 - Direction: Z
 - Buttons: From Pick, Use none
- Buttons: Preview, Help, OK, Apply, Cancel

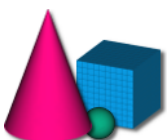
The name of this part is set to “section2” and its medium is chosen to be *concrete*. The length of this section is 7.5 mm. The concrete filled part is placed behind the *section1* thus its position in X direction is set to 100 mm. After pressing *OK* button the concrete filled part of the transmission line appears in the project.

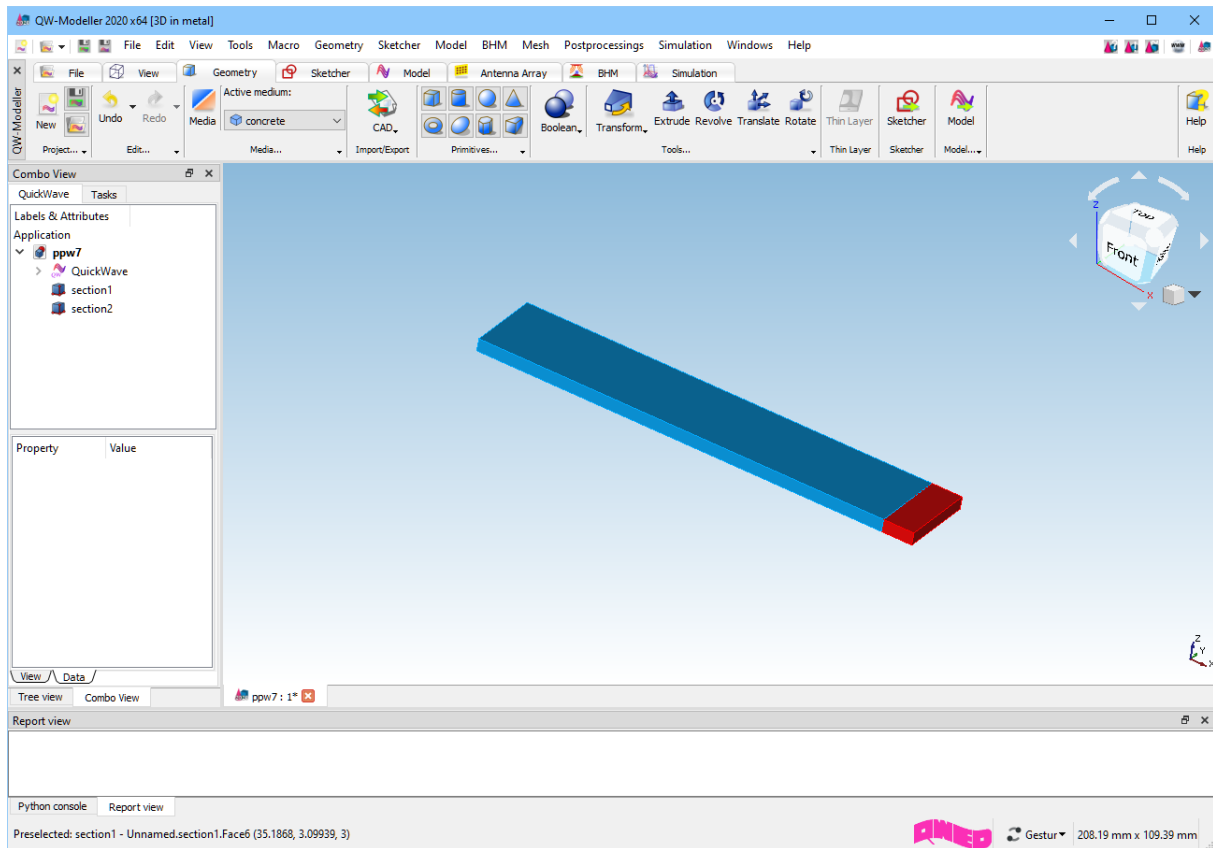



Now the last section is drawn. We press *Create a Box*  button in the *Primitives* section and a dialogue appears.

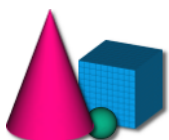

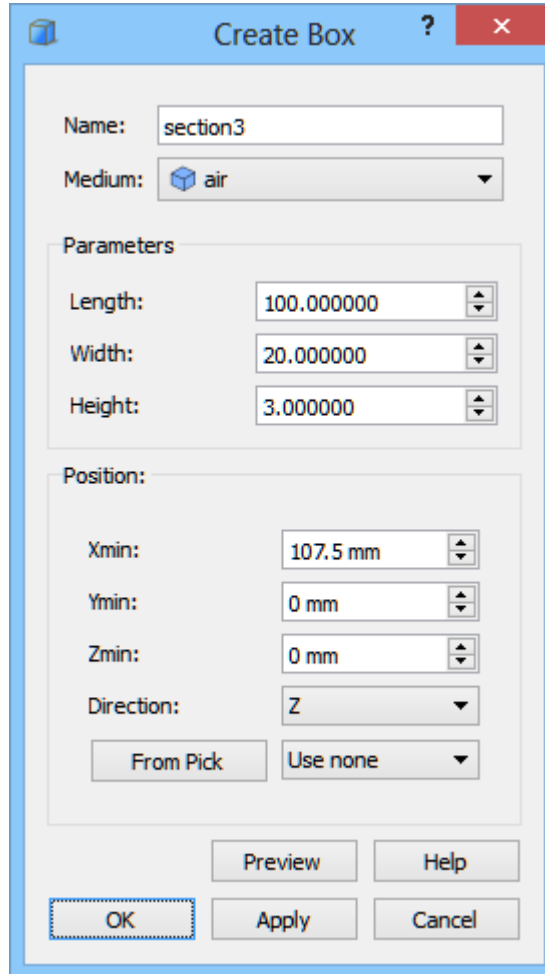

The screenshot shows the 'Create Box' dialog box with the following settings:

- Name: section3
- Medium: air
- Parameters:
 - Length: 100.000000
 - Width: 20.000000
 - Height: 3.000000
- Position:
 - Xmin: 107.5 mm
 - Ymin: 0 mm
 - Zmin: 0 mm
 - Direction: Z
 - Buttons: From Pick, Use none
- Buttons: Preview, Help, OK, Apply, Cancel

The name of this part is set to “section3” and its medium is chosen to be *air*. The dimensions of this section are the same as for *section1*. The position in X direction is set to 107.5 mm. After pressing *OK* button the concrete filled part of the transmission line appears in the project.

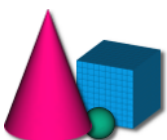

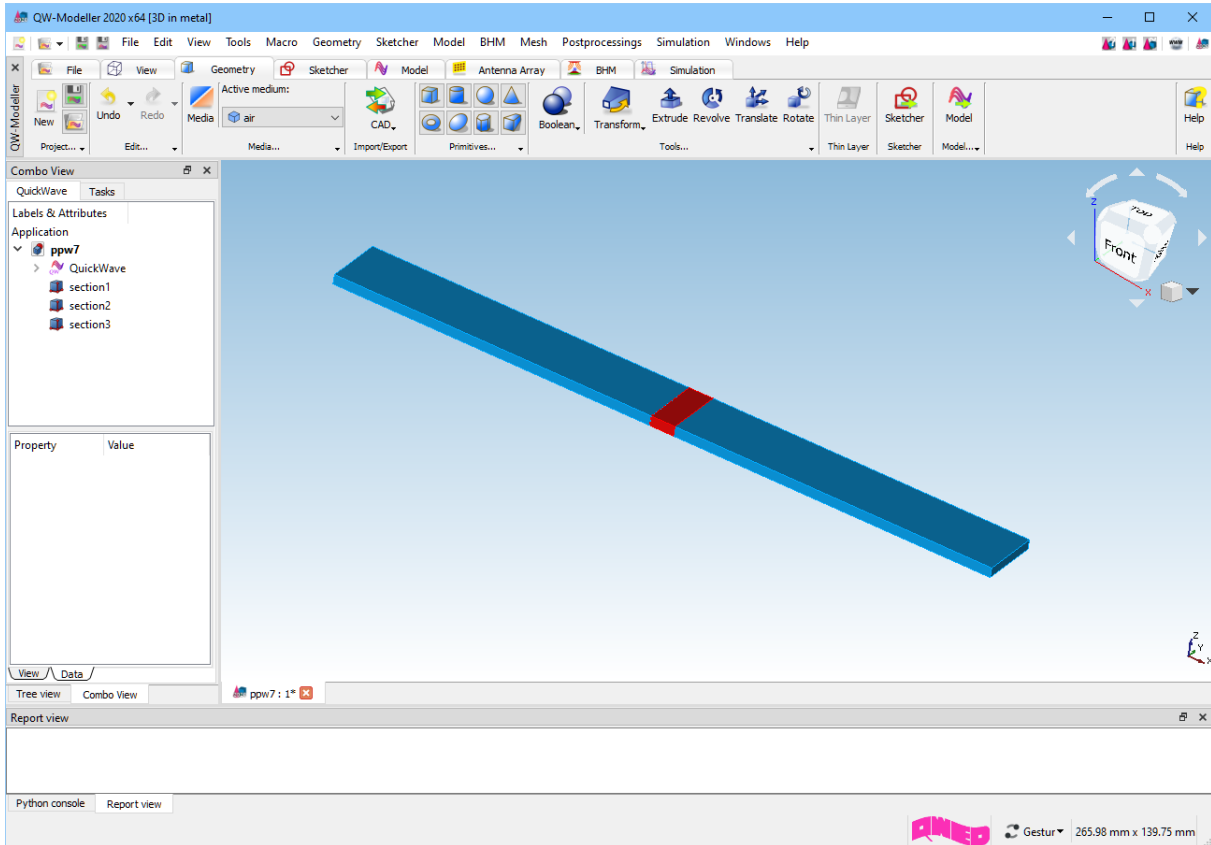

Drawing the ports

In this step we need to draw and define the ports. In this case we need to define two ports, input and output with TEM mode excitation.

To define the ports we need to go to *Model* tab. As a first one, we will define the transmission line

input port. For that purpose we press *Transmission Line*  commands button and choose *Insert Transmission Line Source*  *Insert Transmission Line Source...* command.

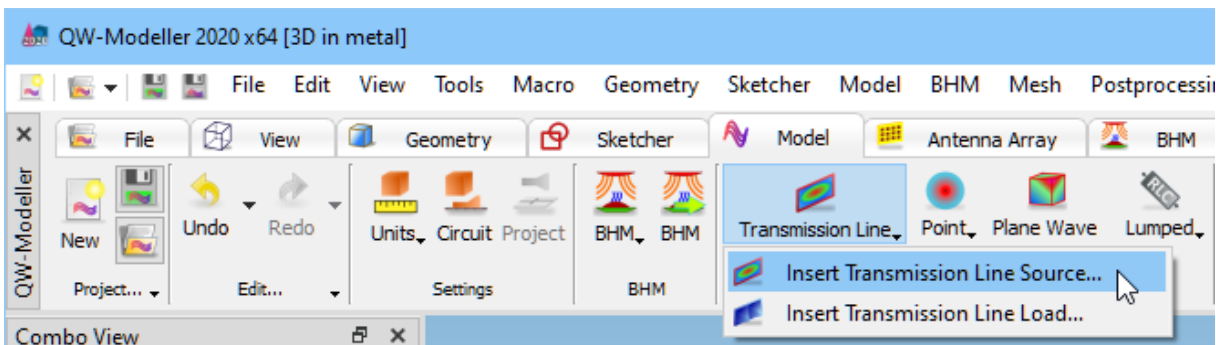

The following dialogue will appear.

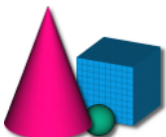

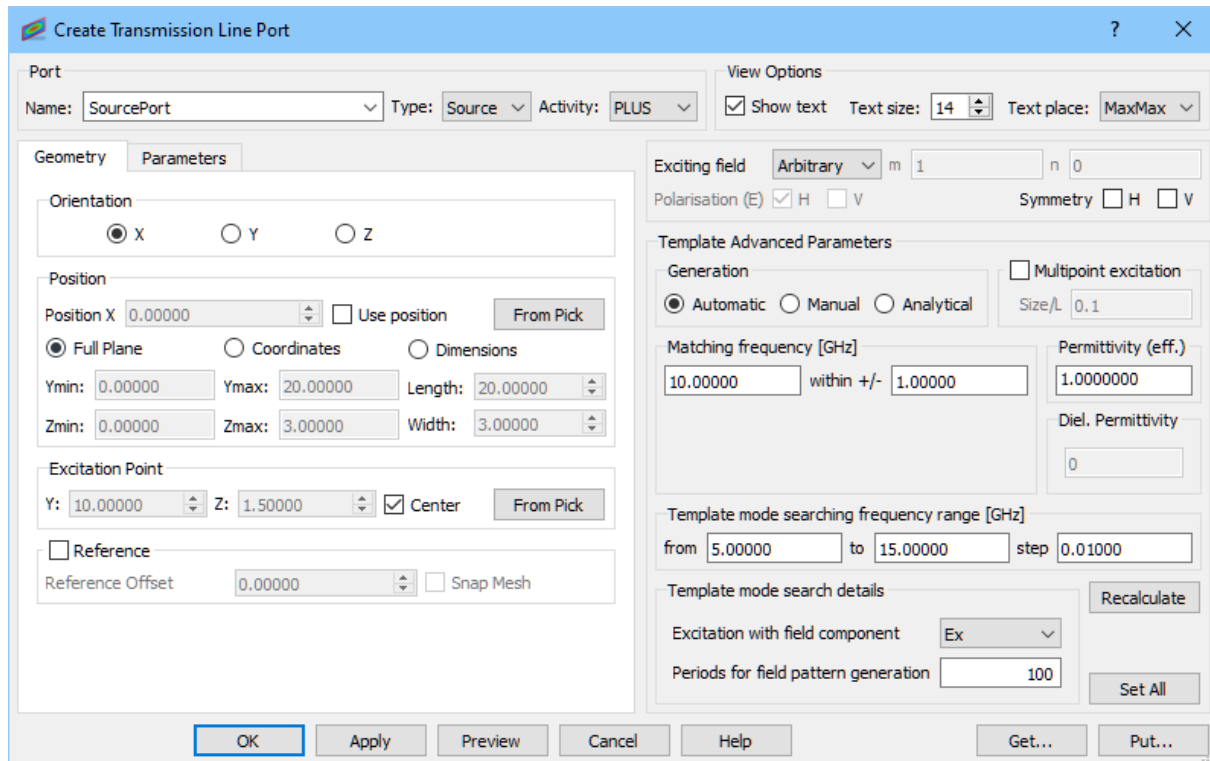

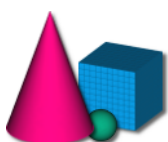
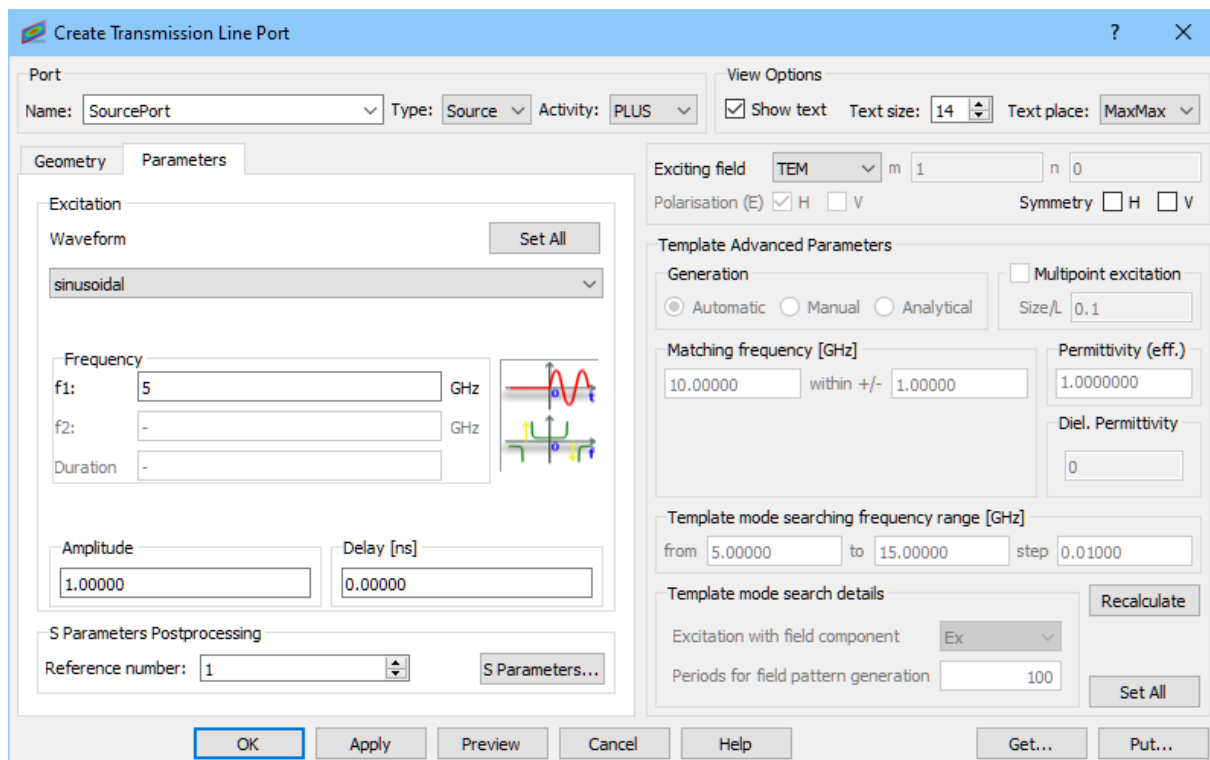

We set the name of the port to *SourcePort*. The default *Type*, *Activity* and *Orientation* of the port are properly set for this case. *Full Plane* option sets the port dimensions equal to the bounding dimensions of the entire project in the directions perpendicular to the port orientation what is suitable in this case. We uncheck the *Reference* option – it is not necessary since we do not calculate S-Parameters.

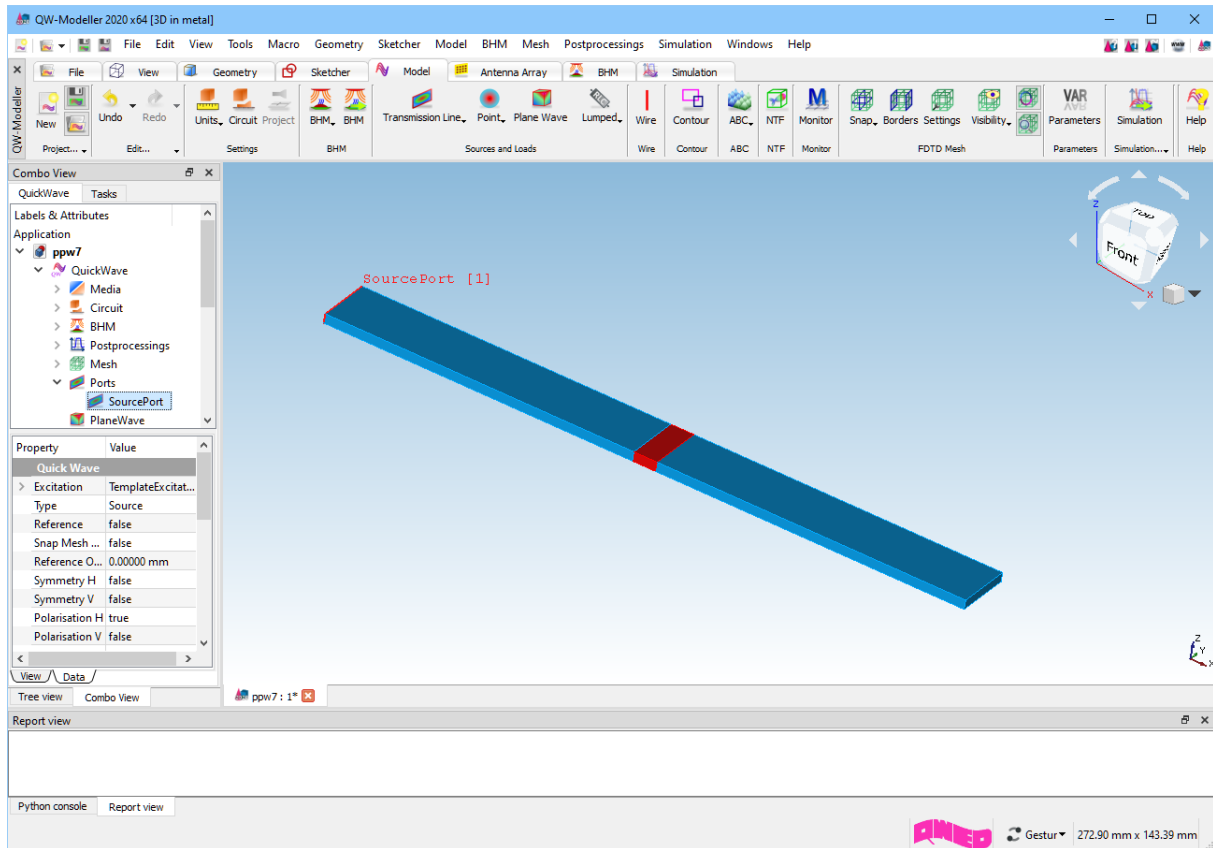

Project Preparation

In the *Parameters* tab we set sinusoidal excitation at 5GHz. We excite the structure with a fundamental TEM mode. Pressing *OK* button accepts the settings.



Now press *Transmission Line*  commands button and choose *Insert Transmission Line Load*  *Insert Transmission Line Load...* command.

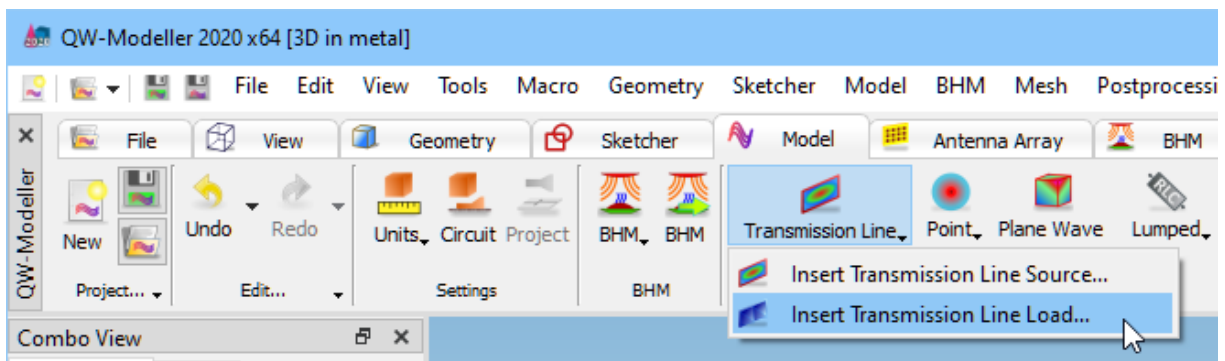

The following dialogue will appear.

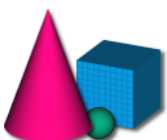

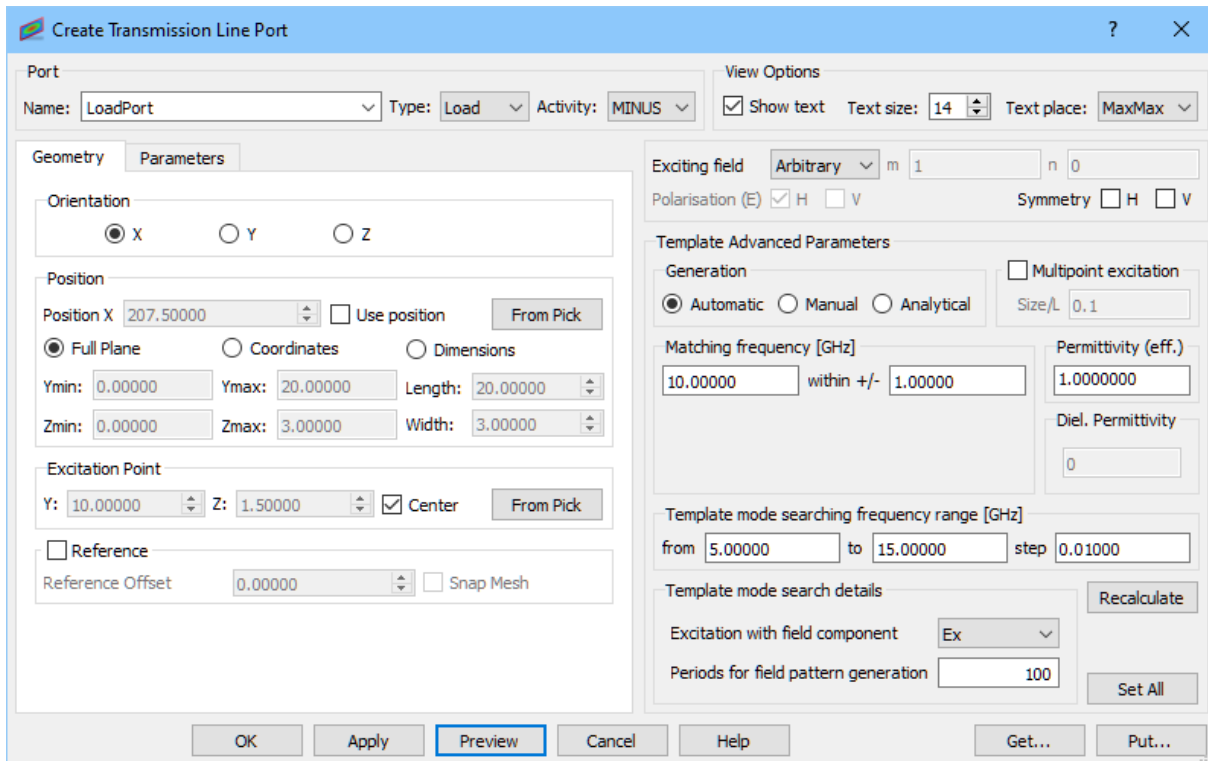

We set the name of the port to *LoadPort*. The default *Type* and *Orientation* of the port are properly set for this case. We should change *Activity* to MINUS (please note that when *Full Plane* option is checked, port will change its position to the opposite side of the project). We uncheck the *Reference* option – it is not necessary since we do not calculate S-Parameters.

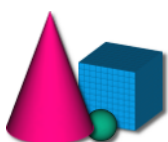
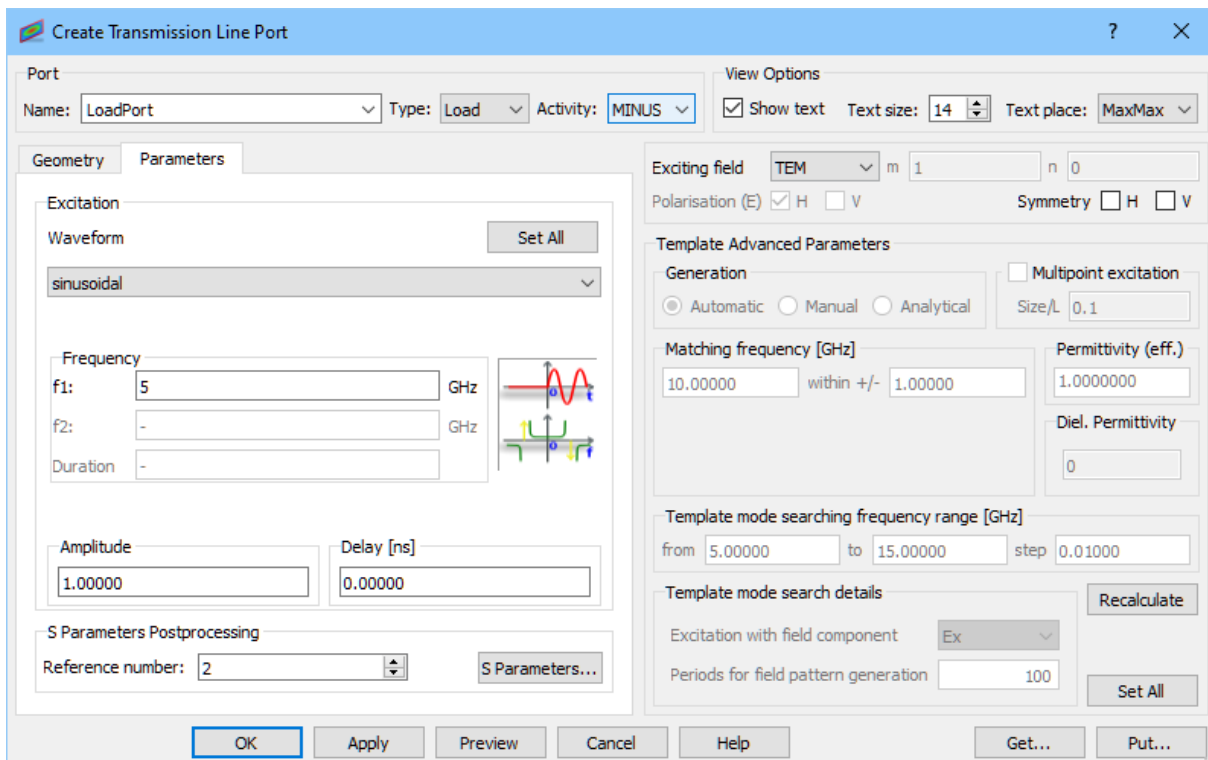

Project Preparation

In the *Parameters* tab we set sinusoidal excitation at 5GHz. We excite the structure with a fundamental TEM mode Pressing *OK* button accepts the settings.

The *LoadPort* can be also set by creating a copy of *SourcePort* and changing its parameters.

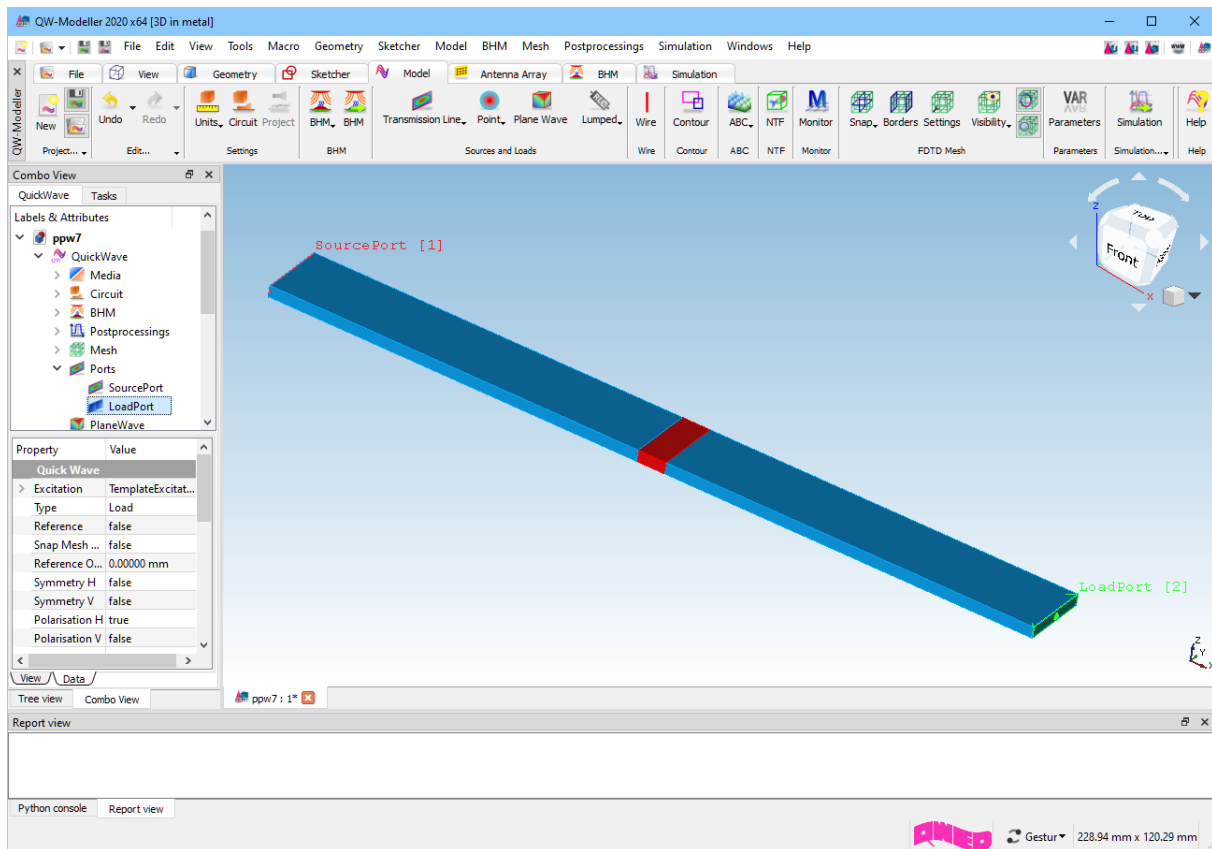

Setting boundary conditions



In the *Model* tab we press the *Borders* button. The *Boundary Conditions* dialogue will appear.

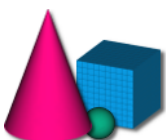

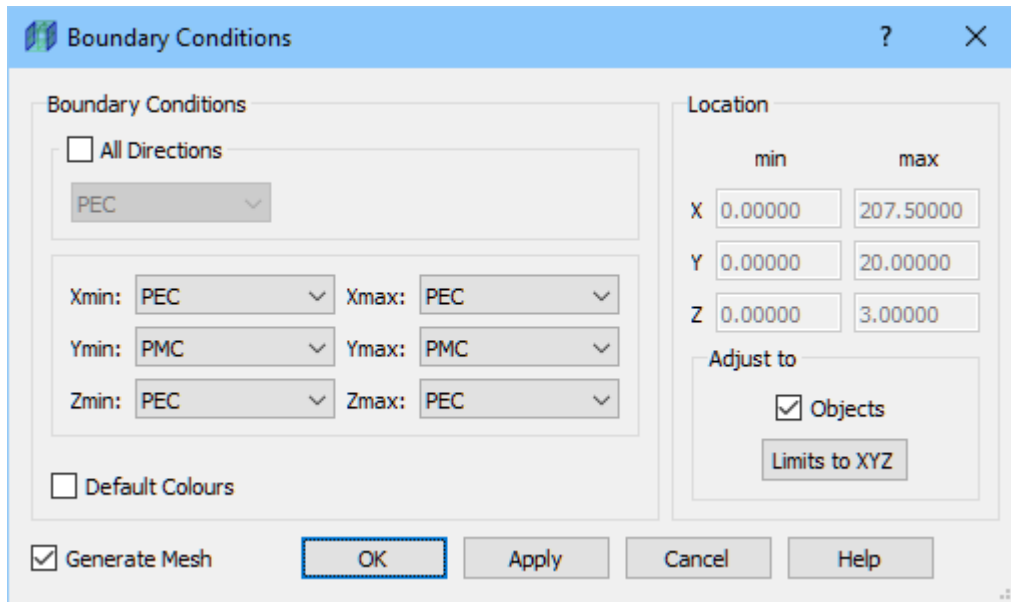

In the *Boundary conditions* frame we uncheck the *All directions* check box and we set *Perfect Magnetic Conductor (PMC)* for *Ymin* and *Ymax* positions and *Perfect Electric Conductor (PEC)* for the rest and press *Apply*. Please note that boundary conditions' indicators are visible when *Boundary Conditions* dialogue is opened or when visibility for *Computational Borders* is enabled. We will make



Boundary Conditions indicators visible using *Visibility* button.

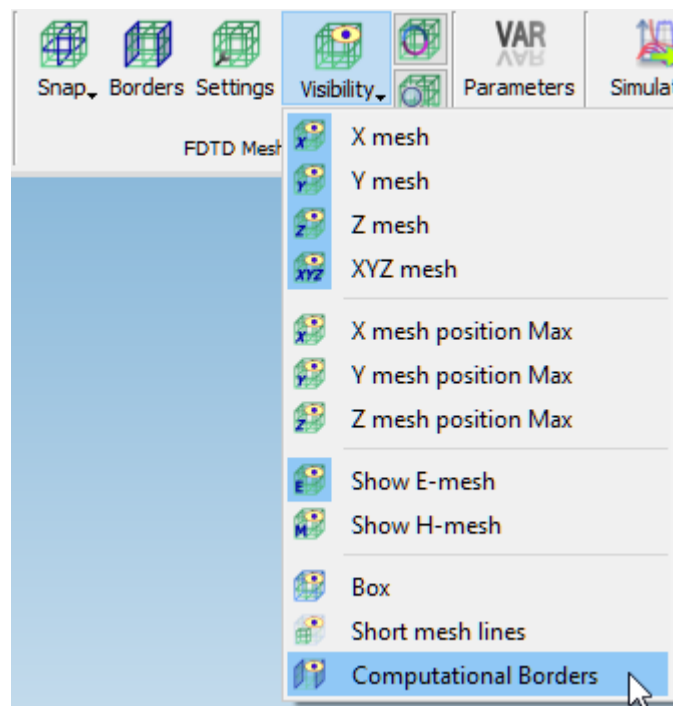

After zooming the display, we can observe that violet colour indicates *PMC* boundary conditions and brown colour indicates *PEC* boundary conditions.

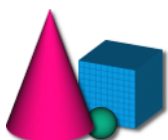

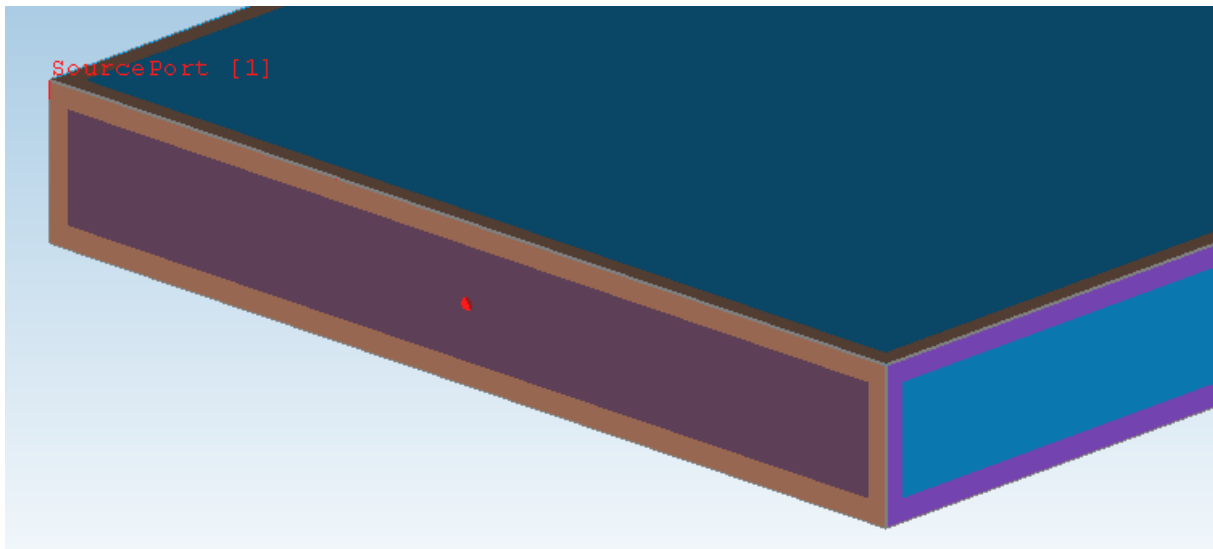

Setting up the mesh

Having the structure's geometry and the ports defined we can now set up the mesh. To do that, in



Model tab we press the *Settings* button. The following dialogue will appear.

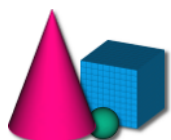

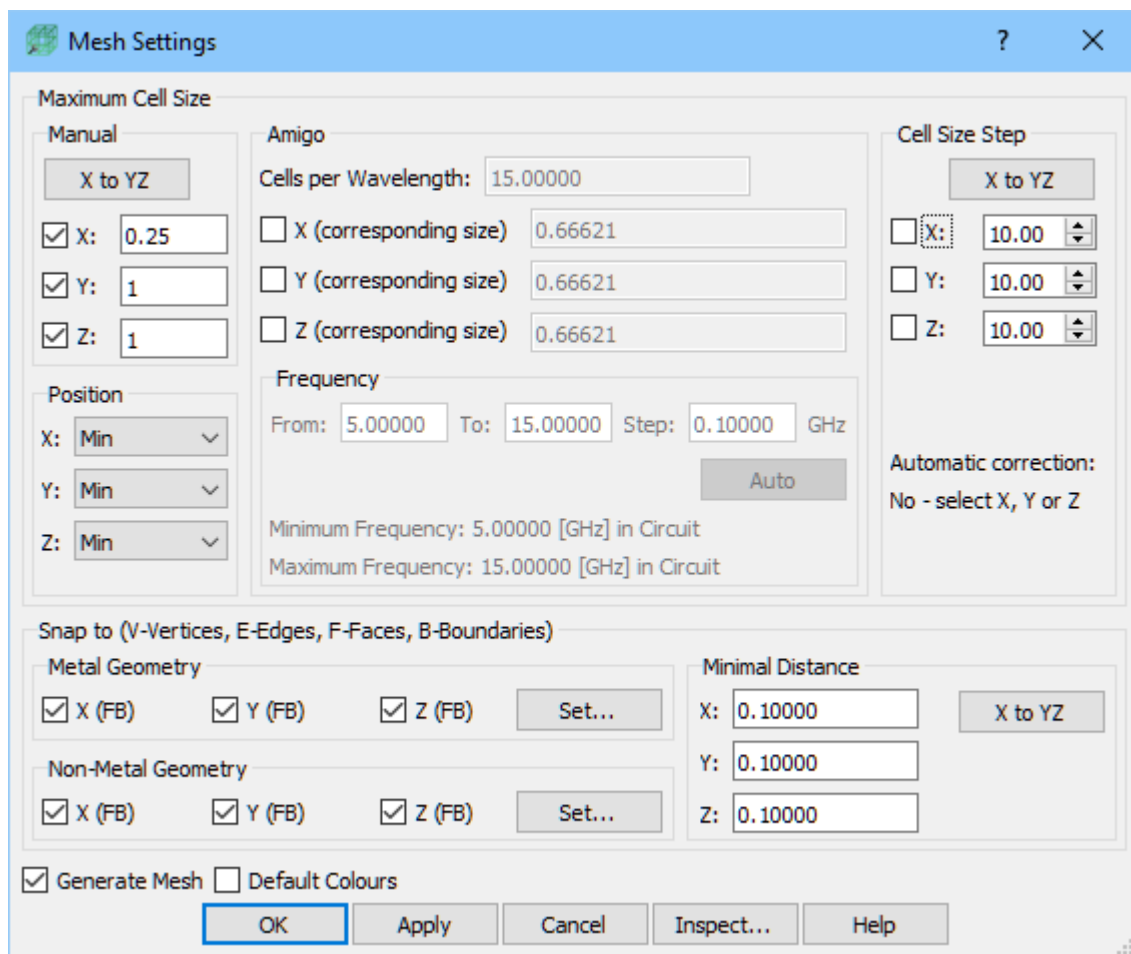

We set 0.25 mm in X direction and 1mm cell sizes in Y and Z direction. The meshing will be enforced in the entire project space.

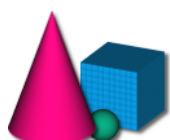

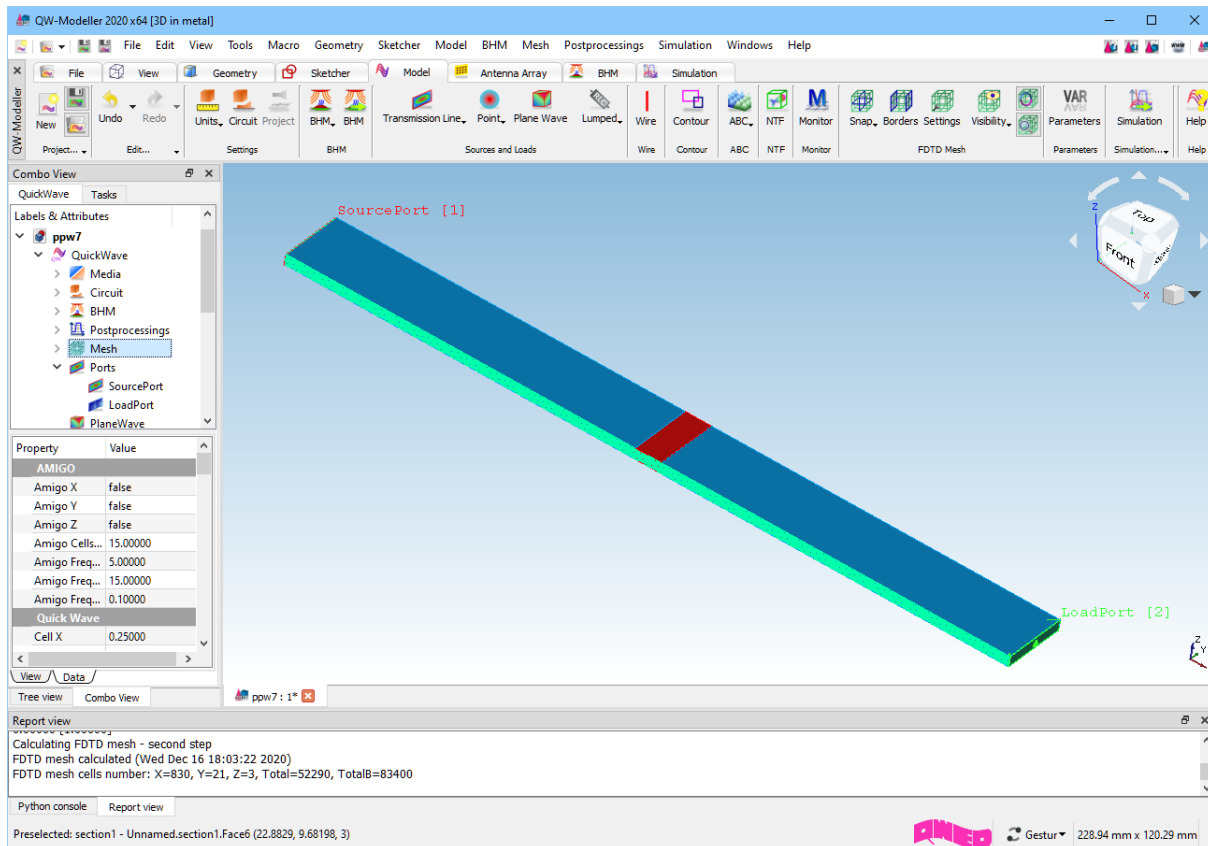

Exporting the project and running the simulation

The project is ready and we can run the simulation. For that purpose we switch to *Simulation* tab and



we press **Start** button from the *Export* section. The *QW-Simulator* is run and the simulation starts automatically. For a detailed description of *QW-Simulator* functionalities please refer to *QW-Simulator* manual.

